



2.22.01

Spécialiste & Conseiller en
**Confort animal &
Équipements de bâtiments**

Mixeurs à **LISIER**

Reck
Agrartechnik



MIXEURS
RÉPARTITEURS

MIXEURS POUR FOSSES ENTERRÉES

MIXEUR GUEPARD TURBO - ARBRE Ø35MM											
RÉF	DÉSIGNATION		LONG. (m)	Ø TUBE (mm)	Ø ARBRE (mm)	DIAMETRE D'HELICE			PIED DE PROTECTION LONG	OPTIONS	
						Ø500	Ø550	Ø600		HACHEUR	PROTECTION GEOMEMBRANE
400000		NU	4	101	35						
400001		Ø500 PIED LONG	4	101	35	X			X		
400002		Ø550 PIED LONG	4	101	35		X		X		
400003		Ø600 PIED LONG	4	101	35			X	X		
400004		Ø500 PIED LONG + PG	4	101	35	X			X		X
400005		Ø550 PIED LONG + PG	4	101	35		X		X		X
400006	4M	Ø600 PIED LONG + PG	4	101	35			X	X		X
400007		Ø500 PIED LONG + HACHEUR	4	101	35	X			X	X	
400008		Ø550 PIED LONG + HACHEUR	4	101	35		X		X	X	
400009		Ø600 PIED LONG + HACHEUR	4	101	35			X	X	X	
400010		Ø500 PIED LG + HACHEUR +PG	4	101	35	X			X	X	X
400011		Ø550 PIED LG + HACHEUR +PG	4	101	35		X		X	X	X
400012		Ø600 PIED LG + HACHEUR +PG	4	101	35			X	X	X	X
219231		NU	5	101	35						
400013		Ø500 PIED LONG	5	101	35	X			X		
400014		Ø550 PIED LONG	5	101	35		X		X		
400015		Ø600 PIED LONG	5	101	35			X	X		
400016		Ø500 PIED LONG + PG	5	101	35	X			X		X
400017		Ø550 PIED LONG + PG	5	101	35		X		X		X
400018	5M	Ø600 PIED LONG + PG	5	101	35			X	X		X
400019		Ø500 PIED LONG + HACHEUR	5	101	35	X			X	X	
400020		Ø550 PIED LONG + HACHEUR	5	101	35		X		X	X	
400021		Ø600 PIED LONG + HACHEUR	5	101	35			X	X	X	
400022		Ø500 PIED LG + HACHEUR +PG	5	101	35	X			X	X	X
400023		Ø550 PIED LG + HACHEUR +PG	5	101	35		X		X	X	X
400024		Ø600 PIED LG + HACHEUR +PG	5	101	35			X	X	X	X
400025		NU	6	101	35						
400026		Ø500 PIED LONG	6	101	35	X			X		
400027		Ø550 PIED LONG	6	101	35		X		X		
400028		Ø600 PIED LONG	6	101	35			X	X		
400029		Ø500 PIED LONG + PG	6	101	35	X			X		X
400030		Ø550 PIED LONG + PG	6	101	35		X		X		X
400031	6M	Ø600 PIED LONG + PG	6	101	35			X	X		X
400032		Ø500 PIED LONG + HACHEUR	6	101	35	X			X	X	
400033		Ø550 PIED LONG + HACHEUR	6	101	35		X		X	X	
400034		Ø600 PIED LONG + HACHEUR	6	101	35			X	X	X	
400035		Ø500 PIED LG + HACHEUR +PG	6	101	35	X			X	X	X
400036		Ø550 PIED LG + HACHEUR +PG	6	101	35		X		X	X	X
400037		Ø600 PIED LG + HACHEUR +PG	6	101	35			X	X	X	X



MIXEURS POUR FOSSES ENTERRÉES

MIXEUR JAGUAR TURBO - ARBRE Ø35MM											
RÉF	DÉSIGNATION		LONG. (m)	Ø TUBE (mm)	Ø ARBRE (mm)	DIAMETRE D'HELICE			PIED DE PROTECTION LONG	OPTIONS	
						Ø500	Ø550	Ø600		HACHEUR	PROTECTION GEOMEMBRANE
204800		NU	4	101	35						
400038		Ø500 PIED LONG	4	101	35	X			X		
400039		Ø550 PIED LONG	4	101	35		X		X		
400040		Ø600 PIED LONG	4	101	35			X	X		
400041		Ø500 PIED LONG + PG	4	101	35	X			X		X
400042		Ø550 PIED LONG + PG	4	101	35		X		X		X
400043	4M	Ø600 PIED LONG + PG	4	101	35			X	X		X
400044		Ø500 PIED LONG + HACHEUR	4	101	35	X			X	X	
400045		Ø550 PIED LONG + HACHEUR	4	101	35		X		X	X	
400046		Ø600 PIED LONG + HACHEUR	4	101	35			X	X	X	
400047		Ø500 PIED LG + HACHEUR +PG	4	101	35	X			X	X	X
400048		Ø550 PIED LG + HACHEUR +PG	4	101	35		X		X	X	X
400049		Ø600 PIED LG + HACHEUR +PG	4	101	35			X	X	X	X
204801		NU	5	101	35						
400050		Ø500 PIED LONG	5	101	35	X			X		
400051		Ø550 PIED LONG	5	101	35		X		X		
400052		Ø600 PIED LONG	5	101	35			X	X		
400053		Ø500 PIED LONG + PG	5	101	35	X			X		X
400054		Ø550 PIED LONG + PG	5	101	35		X		X		X
400055	5M	Ø600 PIED LONG + PG	5	101	35			X	X		X
400056		Ø500 PIED LONG + HACHEUR	5	101	35	X			X	X	
400057		Ø550 PIED LONG + HACHEUR	5	101	35		X		X	X	
400058		Ø600 PIED LONG + HACHEUR	5	101	35			X	X	X	
400059		Ø500 PIED LG + HACHEUR +PG	5	101	35	X			X	X	X
400060		Ø550 PIED LG + HACHEUR +PG	5	101	35		X		X	X	X
400061		Ø600 PIED LG + HACHEUR +PG	5	101	35			X	X	X	X
400062		NU	6	101	35						
400063		Ø500 PIED LONG	6	101	35	X			X		
400064		Ø550 PIED LONG	6	101	35		X		X		
400065		Ø600 PIED LONG	6	101	35			X	X		
400066		Ø500 PIED LONG + PG	6	101	35	X			X		X
400067		Ø550 PIED LONG + PG	6	101	35		X		X		X
400068	6M	Ø600 PIED LONG + PG	6	101	35			X	X		X
400069		Ø500 PIED LONG + HACHEUR	6	101	35	X			X	X	
400070		Ø550 PIED LONG + HACHEUR	6	101	35		X		X	X	
400071		Ø600 PIED LONG + HACHEUR	6	101	35			X	X	X	
400072		Ø500 PIED LG + HACHEUR +PG	6	101	35	X			X	X	X
400073		Ø550 PIED LG + HACHEUR +PG	6	101	35		X		X	X	X
400074		Ø600 PIED LG + HACHEUR +PG	6	101	35			X	X	X	X



MIXEURS POUR FOSSES ENTERRÉES

MIXEUR JAGUAR JUMBO - ARBRE Ø35MM											
RÉF	DÉSIGNATION		LONG. (m)	Ø TUBE (mm)	Ø ARBRE (mm)	DIAMETRE D'HELICE			PIED DE PROTECTION LONG	OPTIONS	
						Ø500	Ø550	Ø600		HACHEUR	PROTECTION GEOMEMBRANE
400075		NU	4	140	35						
400076		Ø500 PIED LONG	4	140	35	X			X		
400077		Ø550 PIED LONG	4	140	35		X		X		
400078		Ø600 PIED LONG	4	140	35			X	X		
400079		Ø500 PIED LONG + PG	4	140	35	X			X		X
400080		Ø550 PIED LONG + PG	4	140	35		X		X		X
400081	4M	Ø600 PIED LONG + PG	4	140	35			X	X		X
400082		Ø500 PIED LONG + HACHEUR	4	140	35	X			X	X	
400083		Ø550 PIED LONG + HACHEUR	4	140	35		X		X	X	
400084		Ø600 PIED LONG + HACHEUR	4	140	35			X	X	X	
400085		Ø500 PIED LG + HACHEUR +PG	4	140	35	X			X	X	X
400086		Ø550 PIED LG + HACHEUR +PG	4	140	35		X		X	X	X
400087		Ø600 PIED LG + HACHEUR +PG	4	140	35			X	X	X	X
400088		NU	5	140	35						
400089		Ø500 PIED LONG	5	140	35	X			X		
400090		Ø550 PIED LONG	5	140	35		X		X		
400091		Ø600 PIED LONG	5	140	35			X	X		
400092		Ø500 PIED LONG + PG	5	140	35	X			X		X
400093		Ø550 PIED LONG + PG	5	140	35		X		X		X
400094	5M	Ø600 PIED LONG + PG	5	140	35			X	X		X
400095		Ø500 PIED LONG + HACHEUR	5	140	35	X			X	X	
400096		Ø550 PIED LONG + HACHEUR	5	140	35		X		X	X	
400097		Ø600 PIED LONG + HACHEUR	5	140	35			X	X	X	
400098		Ø500 PIED LG + HACHEUR +PG	5	140	35	X			X	X	X
400099		Ø550 PIED LG + HACHEUR +PG	5	140	35		X		X	X	X
400100		Ø600 PIED LG + HACHEUR +PG	5	140	35			X	X	X	X
400101		NU	6	140	35						
400102		Ø500 PIED LONG	6	140	35	X			X		
400103		Ø550 PIED LONG	6	140	35		X		X		
400104		Ø600 PIED LONG	6	140	35			X	X		
400105		Ø500 PIED LONG + PG	6	140	35	X			X		X
400106		Ø550 PIED LONG + PG	6	140	35		X		X		X
400107	6M	Ø600 PIED LONG + PG	6	140	35			X	X		X
400108		Ø500 PIED LONG + HACHEUR	6	140	35	X			X	X	
400109		Ø550 PIED LONG + HACHEUR	6	140	35		X		X	X	
400110		Ø600 PIED LONG + HACHEUR	6	140	35			X	X	X	
400111		Ø500 PIED LG + HACHEUR +PG	6	140	35	X			X	X	X
400112		Ø550 PIED LG + HACHEUR +PG	6	140	35		X		X	X	X
400113		Ø600 PIED LG + HACHEUR +PG	6	140	35			X	X	X	X
400114		NU	7	140	35						
400115		Ø500 PIED LONG	7	140	35	X			X		
400116		Ø550 PIED LONG	7	140	35		X		X		
400117		Ø600 PIED LONG	7	140	35			X	X		
400118		Ø500 PIED LONG + PG	7	140	35	X			X		X
400119		Ø550 PIED LONG + PG	7	140	35		X		X		X
400120	7M	Ø600 PIED LONG + PG	7	140	35			X	X		X
400121		Ø500 PIED LONG + HACHEUR	7	140	35	X			X	X	
400122		Ø550 PIED LONG + HACHEUR	7	140	35		X		X	X	
400123		Ø600 PIED LONG + HACHEUR	7	140	35			X	X	X	
400124		Ø500 PIED LG + HACHEUR +PG	7	140	35	X			X	X	X
400125		Ø550 PIED LG + HACHEUR +PG	7	140	35		X		X	X	X
400126		Ø600 PIED LG + HACHEUR +PG	7	140	35			X	X	X	X

MIXEURS POUR FOSSES ENTERRÉES

MIXEUR JAGUAR JUMBO - ARBRE Ø45MM										
RÉF	DÉSIGNATION		LONG. (m)	Ø TUBE (mm)	Ø ARBRE (mm)	Ø D'HELICE		PIED DE PROTECTION LONG	OPTIONS	
						Ø550	Ø600		HACHEUR	PROTECTION GEOMEMBRANE
400127		NU	4	140	45					
400128		Ø550 PIED LONG	4	140	45	X		X		
400129		Ø600 PIED LONG	4	140	45		X	X		
400130	4M	Ø550 PIED LONG + PG	4	140	45	X		X		X
400131		Ø600 PIED LONG + PG	4	140	45		X	X		X
400132		Ø550 PIED LONG + HACHEUR	4	140	45	X		X	X	
400133		Ø600 PIED LONG + HACHEUR	4	140	45		X	X	X	
400134		Ø550 PIED LG + HACHEUR +PG	4	140	45	X		X	X	X
400135		Ø600 PIED LG + HACHEUR +PG	4	140	45		X	X	X	X
400136			NU	5	140	45				
400137		Ø550 PIED LONG	5	140	45	X		X		
400138		Ø600 PIED LONG	5	140	45		X	X		
400139	5M	Ø550 PIED LONG + PG	5	140	45	X		X		X
400140		Ø600 PIED LONG + PG	5	140	45		X	X		X
400141		Ø550 PIED LONG + HACHEUR	5	140	45	X		X	X	
400142		Ø600 PIED LONG + HACHEUR	5	140	45		X	X	X	
400143		Ø550 PIED LG + HACHEUR +PG	5	140	45	X		X	X	X
400144		Ø600 PIED LG + HACHEUR +PG	5	140	45		X	X	X	X
400145			NU	6	140	45				
400146		Ø550 PIED LONG	6	140	45	X		X		
400147		Ø600 PIED LONG	6	140	45		X	X		
400148	6M	Ø550 PIED LONG + PG	6	140	45	X		X		X
400149		Ø600 PIED LONG + PG	6	140	45		X	X		X
400150		Ø550 PIED LONG + HACHEUR	6	140	45	X		X	X	
400151		Ø600 PIED LONG + HACHEUR	6	140	45		X	X	X	
400152		Ø550 PIED LG + HACHEUR +PG	6	140	45	X		X	X	X
400153		Ø600 PIED LG + HACHEUR +PG	6	140	45		X	X	X	X
400154			NU	7	140	45				
400155		Ø550 PIED LONG	7	140	45	X		X		
400156		Ø600 PIED LONG	7	140	45		X	X		
400157	7M	Ø550 PIED LONG + PG	7	140	45	X		X		X
400158		Ø600 PIED LONG + PG	7	140	45		X	X		X
400159		Ø550 PIED LONG + HACHEUR	7	140	45	X		X	X	
400160		Ø600 PIED LONG + HACHEUR	7	140	45		X	X	X	
400161		Ø550 PIED LG + HACHEUR +PG	7	140	45	X		X	X	X
400162		Ø600 PIED LG + HACHEUR +PG	7	140	45		X	X	X	X



MIXEURS POUR FOSSES ENTERRÉES

MIXEUR TYPHON TURBO - ARBRE Ø35MM											
RÉF	DÉSIGNATION		LONG. (m)	Ø TUBE (mm)	Ø ARBRE (mm)	DIAMETRE D'HELICE			PIED DE PROTECTION LONG	OPTIONS	
						Ø500	Ø550	Ø600		HACHEUR	PROTECTION GEOMEMBRANE
400163		NU	4	101	35						
400164		Ø500 PIED LONG	4	101	35	X			X		
400165		Ø550 PIED LONG	4	101	35		X		X		
400166		Ø600 PIED LONG	4	101	35			X	X		
400167		Ø500 PIED LONG + PG	4	101	35	X			X		X
400168		Ø550 PIED LONG + PG	4	101	35		X		X		X
400169	4M	Ø600 PIED LONG + PG	4	101	35			X	X		X
400170		Ø500 PIED LONG + HACHEUR	4	101	35	X			X	X	
400171		Ø550 PIED LONG + HACHEUR	4	101	35		X		X	X	
400172		Ø600 PIED LONG + HACHEUR	4	101	35			X	X	X	
400173		Ø500 PIED LG + HACHEUR +PG	4	101	35	X			X	X	X
400174		Ø550 PIED LG + HACHEUR +PG	4	101	35		X		X	X	X
400175		Ø600 PIED LG + HACHEUR +PG	4	101	35			X	X	X	X
400176		NU	5	101	35						
400177		Ø500 PIED LONG	5	101	35	X			X		
400178		Ø550 PIED LONG	5	101	35		X		X		
400179		Ø600 PIED LONG	5	101	35			X	X		
400180		Ø500 PIED LONG + PG	5	101	35	X			X		X
400181		Ø550 PIED LONG + PG	5	101	35		X		X		X
400182	5M	Ø600 PIED LONG + PG	5	101	35			X	X		X
400183		Ø500 PIED LONG + HACHEUR	5	101	35	X			X	X	
400184		Ø550 PIED LONG + HACHEUR	5	101	35		X		X	X	
400185		Ø600 PIED LONG + HACHEUR	5	101	35			X	X	X	
400186		Ø500 PIED LG + HACHEUR +PG	5	101	35	X			X	X	X
400187		Ø550 PIED LG + HACHEUR +PG	5	101	35		X		X	X	X
400188		Ø600 PIED LG + HACHEUR +PG	5	101	35			X	X	X	X
400189		NU	6	101	35						
400190		Ø500 PIED LONG	6	101	35	X			X		
400191		Ø550 PIED LONG	6	101	35		X		X		
400192		Ø600 PIED LONG	6	101	35			X	X		
400193		Ø500 PIED LONG + PG	6	101	35	X			X		X
400194		Ø550 PIED LONG + PG	6	101	35		X		X		X
400195	6M	Ø600 PIED LONG + PG	6	101	35			X	X		X
400196		Ø500 PIED LONG + HACHEUR	6	101	35	X			X	X	
400197		Ø550 PIED LONG + HACHEUR	6	101	35		X		X	X	
400198		Ø600 PIED LONG + HACHEUR	6	101	35			X	X	X	
400199		Ø500 PIED LG + HACHEUR +PG	6	101	35	X			X	X	X
400200		Ø550 PIED LG + HACHEUR +PG	6	101	35		X		X	X	X
400201		Ø600 PIED LG + HACHEUR +PG	6	101	35			X	X	X	X
400202		NU	7	101	35						
400203		Ø500 PIED LONG	7	101	35	X			X		
400204		Ø550 PIED LONG	7	101	35		X		X		
400205		Ø600 PIED LONG	7	101	35			X	X		
400206		Ø500 PIED LONG + PG	7	101	35	X			X		X
400207		Ø550 PIED LONG + PG	7	101	35		X		X		X
400208	7M	Ø600 PIED LONG + PG	7	101	35			X	X		X
400209		Ø500 PIED LONG + HACHEUR	7	101	35	X			X	X	
400210		Ø550 PIED LONG + HACHEUR	7	101	35		X		X	X	
400211		Ø600 PIED LONG + HACHEUR	7	101	35			X	X	X	
400212		Ø500 PIED LG + HACHEUR +PG	7	101	35	X			X	X	X
400213		Ø550 PIED LG + HACHEUR +PG	7	101	35		X		X	X	X
400214		Ø600 PIED LG + HACHEUR +PG	7	101	35			X	X	X	X

MIXEURS POUR FOSSES ENTERRÉES

MIXEUR TYPHON JUMBO - ARBRE Ø35MM											
RÉF	DÉSIGNATION		LONG. (m)	Ø TUBE (mm)	Ø ARBRE (mm)	DIAMETRE D'HELICE			PIED DE PROTECTION LONG	OPTIONS	
						Ø500	Ø550	Ø600		HACHEUR	PROTECTION GEOMEMBRANE
400215		NU	6	140	35						
400216		Ø500 PIED LONG	6	140	35	X			X		
400217		Ø550 PIED LONG	6	140	35		X		X		
400218		Ø600 PIED LONG	6	140	35			X	X		
400219		Ø500 PIED LONG + PG	6	140	35	X			X		X
400220		Ø550 PIED LONG + PG	6	140	35		X		X		X
400221	6M	Ø600 PIED LONG + PG	6	140	35			X	X		X
400222		Ø500 PIED LONG + HACHEUR	6	140	35	X			X	X	
400223		Ø550 PIED LONG + HACHEUR	6	140	35		X		X	X	
400224		Ø600 PIED LONG + HACHEUR	6	140	35			X	X	X	
400225		Ø500 PIED LG + HACHEUR +PG	6	140	35	X			X	X	X
400226		Ø550 PIED LG + HACHEUR +PG	6	140	35		X		X	X	X
400227		Ø600 PIED LG + HACHEUR +PG	6	140	35			X	X	X	X
400228		NU	7	140	35						
400229		Ø500 PIED LONG	7	140	35	X			X		
400230		Ø550 PIED LONG	7	140	35		X		X		
400231		Ø600 PIED LONG	7	140	35			X	X		
400232		Ø500 PIED LONG + PG	7	140	35	X			X		X
400233		Ø550 PIED LONG + PG	7	140	35		X		X		X
400234	7M	Ø600 PIED LONG + PG	7	140	35			X	X		X
400235		Ø500 PIED LONG + HACHEUR	7	140	35	X			X	X	
400236		Ø550 PIED LONG + HACHEUR	7	140	35		X		X	X	
400237		Ø600 PIED LONG + HACHEUR	7	140	35			X	X	X	
400238		Ø500 PIED LG + HACHEUR +PG	7	140	35	X			X	X	X
400239		Ø550 PIED LG + HACHEUR +PG	7	140	35		X		X	X	X
400240		Ø600 PIED LG + HACHEUR +PG	7	140	35			X	X	X	X
400241		NU	8	140	35						
400242		Ø500 PIED LONG	8	140	35	X			X		
400243		Ø550 PIED LONG	8	140	35		X		X		
400244		Ø600 PIED LONG	8	140	35			X	X		
400245		Ø500 PIED LONG + PG	8	140	35	X			X		X
400246		Ø550 PIED LONG + PG	8	140	35		X		X		X
400247	8M	Ø600 PIED LONG + PG	8	140	35			X	X		X
400248		Ø500 PIED LONG + HACHEUR	8	140	35	X			X	X	
400249		Ø550 PIED LONG + HACHEUR	8	140	35		X		X	X	
400250		Ø600 PIED LONG + HACHEUR	8	140	35			X	X	X	
400251		Ø500 PIED LG + HACHEUR +PG	8	140	35	X			X	X	X
400252		Ø550 PIED LG + HACHEUR +PG	8	140	35		X		X	X	X
400253		Ø600 PIED LG + HACHEUR +PG	8	140	35			X	X	X	X

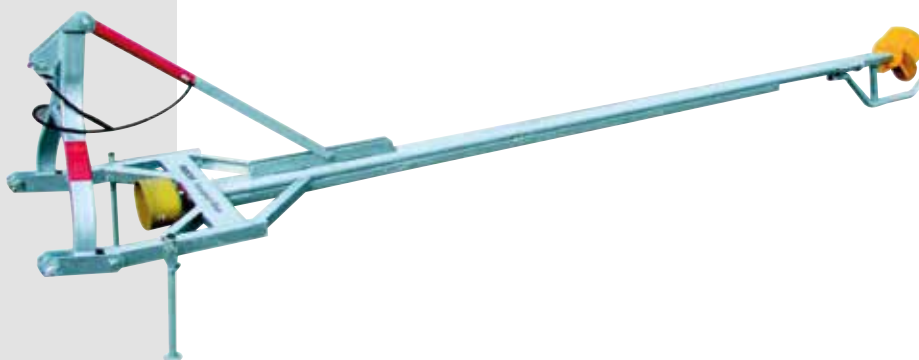

MIXEURS POUR FOSSES ENTERRÉES

MIXEUR TYPHON TURBO - ARBRE Ø45MM										
RÉF	DÉSIGNATION		LONG. (m)	Ø TUBE (mm)	Ø ARBRE (mm)	Ø D'HELICE		PIED DE PROTECTION LONG	OPTIONS	
						Ø550	Ø600		HACHEUR	PROTECTION GEOMEMBRANE
400254		NU	6	140	45					
400255		Ø550 PIED LONG	6	140	45	X		X		
400256		Ø600 PIED LONG	6	140	45		X	X		
400257		Ø550 PIED LONG + PG	6	140	45	X		X		X
400258	6M	Ø600 PIED LONG + PG	6	140	45		X	X		X
400259		Ø550 PIED LONG + HACHEUR	6	140	45	X		X	X	
400260		Ø600 PIED LONG + HACHEUR	6	140	45		X	X	X	
400261		Ø550 PIED LG + HACHEUR +PG	6	140	45	X		X	X	X
400262		Ø600 PIED LG + HACHEUR +PG	6	140	45		X	X	X	X
400263		NU	7	140	45					
400264		Ø550 PIED LONG	7	140	45	X		X		
400265		Ø600 PIED LONG	7	140	45		X	X		
400266		Ø550 PIED LONG + PG	7	140	45	X		X		X
400267	7M	Ø600 PIED LONG + PG	7	140	45		X	X		X
400268		Ø550 PIED LONG + HACHEUR	7	140	45	X		X	X	
400269		Ø600 PIED LONG + HACHEUR	7	140	45		X	X	X	
400270		Ø550 PIED LG + HACHEUR +PG	7	140	45	X		X	X	X
400271		Ø600 PIED LG + HACHEUR +PG	7	140	45		X	X	X	X
400272		NU	8	140	45					
400273		Ø550 PIED LONG	8	140	45	X		X		
400274		Ø600 PIED LONG	8	140	45		X	X		
400275		Ø550 PIED LONG + PG	8	140	45	X		X		X
400276	8M	Ø600 PIED LONG + PG	8	140	45		X	X		X
400277		Ø550 PIED LONG + HACHEUR	8	140	45	X		X	X	
400278		Ø600 PIED LONG + HACHEUR	8	140	45		X	X	X	
400279		Ø550 PIED LG + HACHEUR +PG	8	140	45	X		X	X	X
400280		Ø600 PIED LG + HACHEUR +PG	8	140	45		X	X	X	X
400281		NU	9	140	45					
400282		Ø550 PIED LONG	9	140	45	X		X		
400283		Ø600 PIED LONG	9	140	45		X	X		
400284		Ø550 PIED LONG + PG	9	140	45	X		X		X
400285	9M	Ø600 PIED LONG + PG	9	140	45		X	X		X
400286		Ø550 PIED LONG + HACHEUR	9	140	45	X		X	X	
400287		Ø600 PIED LONG + HACHEUR	9	140	45		X	X	X	
400288		Ø550 PIED LG + HACHEUR +PG	9	140	45	X		X	X	X
400289		Ø600 PIED LG + HACHEUR +PG	9	140	45		X	X	X	X

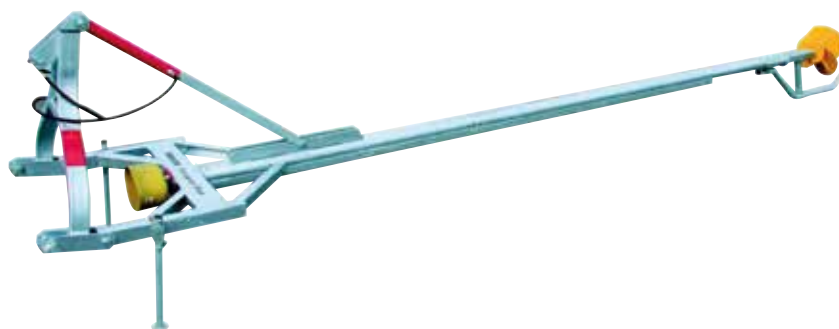

MIXEURS POUR FOSSES ENTERRÉES

MIXEUR TYPHON MORE - ARBRE Ø45MM

RÉF	DÉSIGNATION		LONG. (m)	Ø TUBE (mm)	Ø ARBRE (mm)	DIAMETRE D'HELICE			PIED DE PROTECTION LONG	OPTIONS	
						Ø500	Ø550	Ø600		HACHEUR	PROTECTION GEOMEMBRANE
204848	9.3M	HELICE Ø600 ARBRE Ø45	9	140	45			X			
414836	10.3M	HELICE Ø600 ARBRE Ø45	10	140	45			X			
204934	11.3M	HELICE Ø600 ARBRE Ø45	11	140	45			X			



ACCESSOIRES - MIXEURS POUR FOSSES ENTERRÉES

ACCESSOIRES - MIXEURS GUEPARD / JAGUAR / TYPHON		
N°	RÉF	DÉSIGNATION
1	218703	PIED DE PROTECTION LONG CHASSIS Ø140 - POUR MIXEUR RECK
2	218276	HELICE HAUTE PERFORMANCE Ø550 - POUR MIXEUR RECK ARBRE 35
2	218277	HELICE HAUTE PERFORMANCE Ø600 - POUR MIXEUR RECK
2	218278	HELICE HAUTE PERFORMANCE Ø500 - POUR MIXEUR RECK
4	207809	PIED DE PROTECTION POUR FOSSE GEOMEMBRANE
2	204813	HELICE HAUTE PERFORMANCE Ø600 - POUR MIXEUR RECK ARBRE Ø45
2	204909	HELICE HAUTE PERFORMANCE Ø550 - ARBRE Ø45 RECK
3	204814	HACHEUR HAUTE PERFORMANCE - MIXEUR RECK PR ARBRE Ø45
3	218331	HACHEUR HAUTE PERFORMANCE - MIXEUR RECK PR ARBRE Ø35
1	218279	PIED DE PROTECTION LONG CHASSIS Ø101 - POUR MIXEUR RECK
5	205958	BOITIER INVERSEUR PR MIXEUR RECK PR ARBRE Ø45
5	218330	BOITIER INVERSEUR PR MIXEUR RECK PR ARBRE Ø35

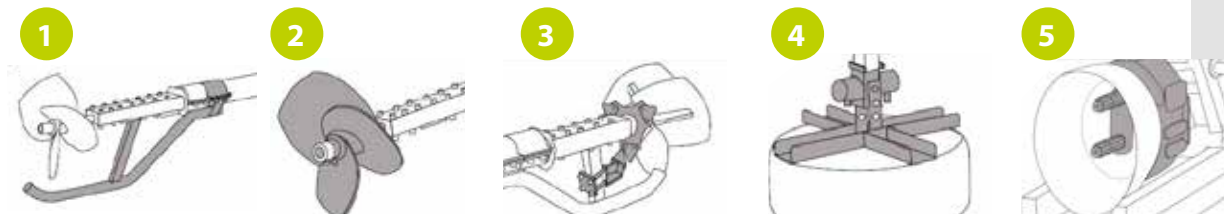

TRANSMISSIONS	
RÉF	DÉSIGNATION
446663	TRANSMISSION STANDARD LG1010 1"3/8 6 CANNELURES Ø35
446664	TRANSMISSION STANDARD LG1010 1"3/4-1"3/8 6 CANNUELURES Ø35
446665	TRANSMISSION GRAND ANGLE LG1010 1"3/8 6 CANNELURES Ø35
446666	TRANSMISSION AVEC LIMITEUR A BOULON LG1010 1"3/8 6 CANNELURES Ø35
446667	TRANSMISSION GRAND ANGLE BILATERAL LG1010 1"3/8 6 CANNELURES Ø45

Transmission à inversion

Cardan

RALLONGE DE CHASSIS

RALLONGE DE CHASSIS OCELOT

RÉF	DÉSIGNATION
205379	RALLONGE CHASSIS OCELOT LG 2,5M PR HAUTEUR 1M75 RECK
205462	RALLONGE CHASSIS OCELOT LG 4M PR HAUTEUR 2,4M RECK
205386	RALLONGE CHASSIS OCELOT LG 5M PR HAUTEUR 3M RECK

A COMBINER AVEC UN MIXEUR JAGUAR OU TYPHON



TRANSMISSIONS

RÉF	DÉSIGNATION
446663	TRANSMISSION STANDARD LG1010 1"3/8 6 CANNELURES
446664	TRANSMISSION STANDARD LG1010 1"3/4-1"3/8 6 CANNUELURES
446665	TRANSMISSION GRAND ANGLE LG1010 1"3/8 6 CANNELURES
446666	TRANSMISSION AVEC LIMITEUR A BOULON LG1010 1"3/8 6 CANNELURES
446667	TRANSMISSION GRAND ANGLE BILATERAL LG1010 1"3/8 6 CANNELURES

MIXEURS POUR FOSSES ENTERRÉES ET LAGUNES

MIXEUR HERCULES	
RÉF	DÉSIGNATION
441601	MIXEUR A PRISE DE FORCE HERCULE 7M ARBRE Ø45
204868	MIXEUR A PRISE DE FORCE HERCULE 9M ARBRE Ø45

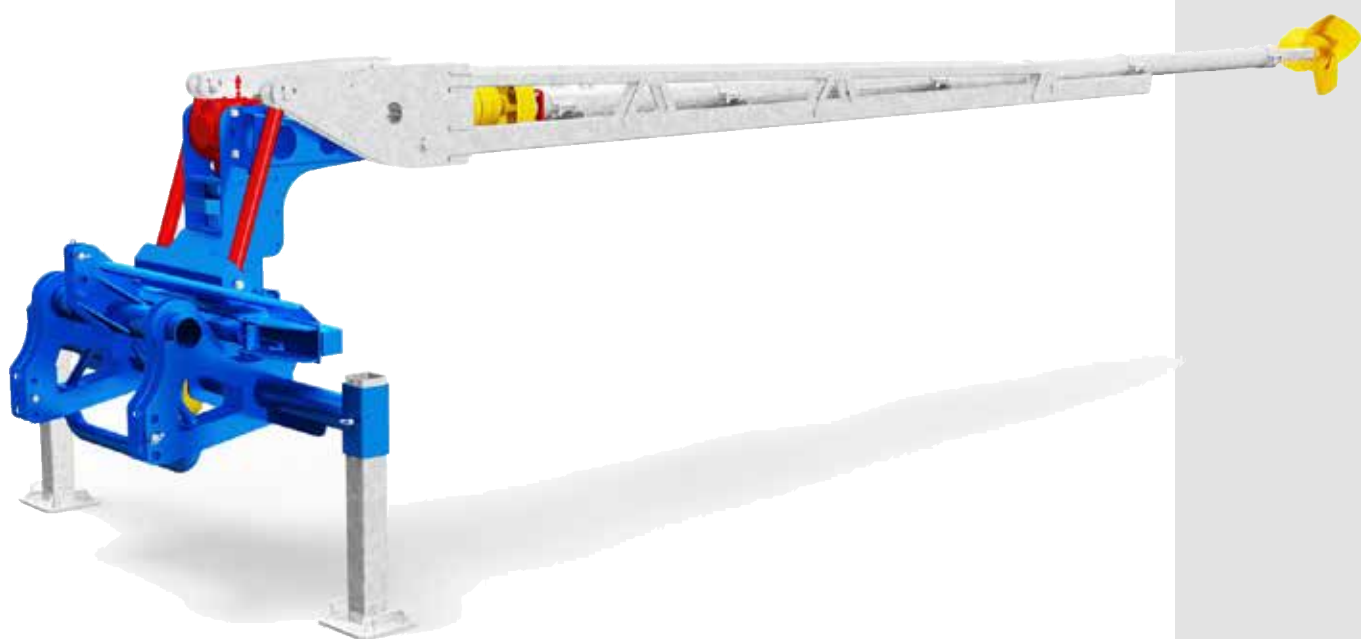

ACCESSOIRES MIXEURS POUR FOSSES ENTERRÉES ET LAGUNES

ACCESSOIRES - MIXEUR HERCULES		
N°	RÉF	DÉSIGNATION
1	204814	HACHEUR HAUTE PERFORMANCE PR MIXEUR RECK PR ARBRE Ø45
2	204867	PIED DE MAINTIEN REGLABLE HYDRAULIQUEMENT PR HERCULES
3	218703	PIED DE PROTECTION LONG CHASSIS Ø140 PR MIXEUR RECK
4	219246	PIED DE PROTECTION POUR FOSSE GEOMEMBRANE RECK
5	204937	ANNEAU DE PROTECTION HELICEPR CHASSIS Ø140
-	204866	CARDAN WALTERSCHEID W2600-860

1

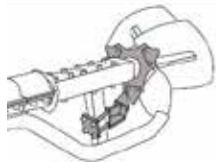

2

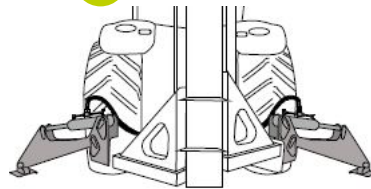

3



4

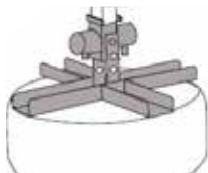

5

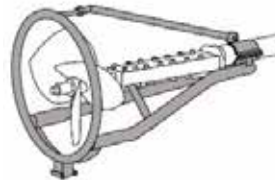

MIXEURS POUR FOSSES LAGUNES

MIXEUR BLIZZARD			
RÉF	VERSION	DÉSIGNATION	
204588	VERSION GALVA CHASSIS Ø101	MIXEUR BLIZZARD 4M 10CV	HELICE Ø440
219697		MIXEUR BLIZZARD 4M 20CV	HELICE Ø500
204845		MIXEUR BLIZZARD 5M 7.5CV	HELICE Ø400
414405		MIXEUR BLIZZARD 5M 10CV	HELICE Ø440
205674		MIXEUR BLIZZARD 5M 15CV	HELICE Ø500
204957		MIXEUR BLIZZARD 5M 20CV	HELICE Ø500
219553		MIXEUR BLIZZARD 5M 25CV	HELICE Ø550
441901		MIXEUR BLIZZARD 6M 10CV	HELICE Ø440
204208		MIXEUR BLIZZARD 6M 15CV	HELICE Ø500
205366		MIXEUR BLIZZARD 6M 20CV	HELICE Ø500
219795		MIXEUR BLIZZARD 6M 25CV	HELICE Ø550
204591		MIXEUR BLIZZARD 6M 30CV	HELICE Ø600
204905		MIXEUR BLIZZARD 7M 15CV	HELICE Ø500
218843		MIXEUR BLIZZARD 7M 20CV	HELICE Ø500
205749		MIXEUR BLIZZARD 7M 25CV	HELICE Ø550
204112	VERSION INOX CHASSIS Ø101	MIXEUR BLIZZARD 4M 15CV INOX	HELICE Ø500
411173		MIXEUR BLIZZARD 4M 25CV INOX	HELICE Ø550
207776		MIXEUR BLIZZARD 4M 30CV INOX	HELICE Ø600
204893		MIXEUR BLIZZARD 5M 10CV INOX	HELICE Ø440
204863		MIXEUR BLIZZARD 5M 15CV INOX	HELICE Ø500
204671		MIXEUR BLIZZARD 5M 20CV INOX	HELICE Ø500
205806		MIXEUR BLIZZARD 5M 25CV INOX	HELICE Ø550
204632		MIXEUR BLIZZARD 6M 15CV INOX	HELICE Ø500
204582		MIXEUR BLIZZARD 6M 20CV INOX	HELICE Ø500
204833		MIXEUR BLIZZARD 6M 25CV INOX	HELICE Ø550
204700		MIXEUR BLIZZARD 6M 30CV INOX	HELICE Ø600
415295		MIXEUR BLIZZARD 7M 15CV INOX	HELICE Ø500
204823	MIXEUR BLIZZARD 7M 20CV INOX	HELICE Ø500	
219573	VERSION GALVA CHASSIS Ø140	MIXEUR BLIZZARD 4M 20CV JUMBO	HELICE Ø500
441150		MIXEUR BLIZZARD 6M 25CV JUMBO	HELICE Ø550
441629		MIXEUR BLIZZARD 7M 20CV JUMBO	HELICE Ø500
415227		MIXEUR BLIZZARD 7M 25CV JUMBO	HELICE Ø550
441310		MIXEUR BLIZZARD 8M 15CV JUMBO	HELICE Ø500
204598		MIXEUR BLIZZARD 8M 25CV JUMBO	HELICE Ø550
411713		MIXEUR BLIZZARD 9M 25CV JUMBO	HELICE Ø550



ACCESSOIRES MIXEURS POUR FOSSES LAGUNES

ACCESSOIRES - MIXEUR BLIZZARD

N°	RÉF	DÉSIGNATION
1	218331	HACHEUR HAUTE PERFORMANCE PR MIXEUR RECK PR ARBRE Ø35
1	204814	HACHEUR HAUTE PERFORMANCE PR MIXEUR RECK PR ARBRE Ø45
1	204670	HACHEUR HAUTE PERFORMANCE PR MIXEUR RECK PR ARBRE Ø35 INOX
-	204603	COMMANDE AUTOMATIQUE A DEMARRAGE PROGRESSIF POUR 15KW/20CV
-	204604	COMMANDE AUTOMATIQUE A DEMARRAGE PROGRESSIF POUR 18KW/25CV
-	204605	COMMANDE AUTOMATIQUE A DEMARRAGE PROGRESSIF POUR 22KW/30CV
2	205675	FIXATION POUR RESERVOIR A LISIER BETON PR CHASSIS Ø101
3	204596	FIXATION POUR RESERVOIR A LISIER BETONPR CHASSIS Ø140
4	219712	FIXATION POUR LAGUNE/FOSSE GEOMENBRANE CHASSIS Ø101
5	204580	FIXATION POUR LAGUNE/FOSSE GEOMENBRANE CHASSIS Ø140
6	205808	FIXATION POUR FOSSE COUVERTE
7	219246	PIED DE PROTECTION POUR FOSSE GEOMEMBRANE RECK
8	204937	ANNEAU DE PROTECTION HELICE PR CHASSIS Ø140

1

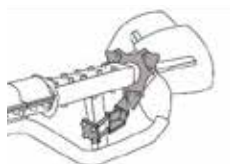

2



3



4



5



6



7

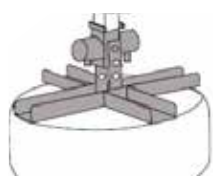

8



MIXEURS POUR FOSSES AÉRIENNES

MIXEUR MAMMOUTH			
RÉF	VERSION	DÉSIGNATION	
204650	STANDARD	MIXEUR MAMMOUTH JUMBO 3/7M	ARBRE Ø 35
204870	RENFORCÉ	MIXEUR MAMMOUTH JUMBO 3/8M	ARBRE Ø 45
410682		MIXEUR MAMMOUTH JUMBO 3.5/8M	ARBRE Ø 45
442103		MIXEUR MAMMOUTH JUMBO 5/9M	ARBRE Ø 45
205887		MIXEUR MAMMOUTH JUMBO 6/9M	ARBRE Ø 45
411731	TITAN	MIXEUR MAMMOUTH TITAN 6/9M	ARBRE Ø 45

AUTRES DIMENSIONS HAUTEUR/BRAS DISPONIBLES SUR DEMANDE



ACCESSOIRES MIXEURS POUR FOSSES AÉRIENNES

ACCESSOIRES - MIXEUR MAMMOUTH		
N°	RÉF	DÉSIGNATION
-	204649	OPTION TOUR PIVOTANTE MANUELLE
1	410683	APPUI DU BRAS DE BRASSAGE POUR MIXEUR MAMMOUTH
2	205890	PLATEFORME SUR TOUR PR MIXEUR MAMMOUTH
	205891	ECHELLE D'ACCES A LA PLATEFORME PR MIXEUR MAMMOUTH RECK
3	204869	PIED REGLABLE EN HAUTEUR PR MIXEUR MAMMOUTH
4	411733	PIED DE MAINTIEN HYDRAULIQUE
5	218703	PIED DE PROTECTION LONG CHASSIS Ø140 PR MIXEUR RECK
6	411732	KIT TRANSPORT ROUTIER
-	205888	TRANSMISSION WALTERSCHEID W2500 LG 860 RECK
-	204866	CARDAN WALTERSCHEID W2600-860

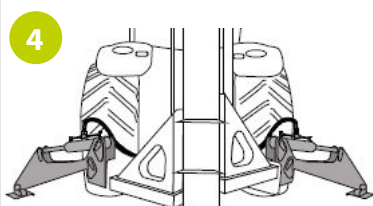
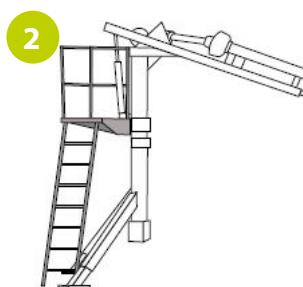
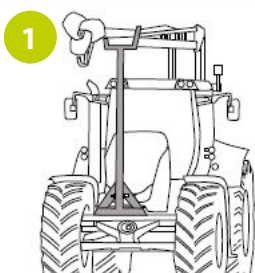

MIXEURS SLALOM

MIXEUR ORKA	
RÉF	DÉSIGNATION
204508	MIXEUR IMMERGE ORKA 10 CV Ø HELICE INOX 480MM CABLE 10M
415531	MIXEUR IMMERGE ORKA 10 CV Ø HELICE INOX 480MM CABLE 20M
415532	MIXEUR IMMERGE ORKA 10 CV Ø HELICE INOX 480MM CABLE 30M
415533	MIXEUR IMMERGE ORKA 10 CV Ø HELICE INOX 480MM CABLE 40M
204509	MIXEUR IMMERGE ORKA 15 CV Ø HELICE INOX 500MM CABLE 10M
415534	MIXEUR IMMERGE ORKA 15 CV Ø HELICE INOX 500MM CABLE 20M
415535	MIXEUR IMMERGE ORKA 15 CV Ø HELICE INOX 500MM CABLE 30M
415536	MIXEUR IMMERGE ORKA 15 CV Ø HELICE INOX 500MM CABLE 40M
204510	MIXEUR IMMERGE ORKA 20 CV Ø HELICE INOX 550MM CABLE 10M
415543	MIXEUR IMMERGE ORKA 20 CV Ø HELICE INOX 550MM CABLE 20M
415544	MIXEUR IMMERGE ORKA 20 CV Ø HELICE INOX 550MM CABLE 30M
415545	MIXEUR IMMERGE ORKA 20 CV Ø HELICE INOX 550MM CABLE 40M
204511	MIXEUR IMMERGE ORKA 25 CV Ø HELICE INOX 600MM CABLE 10M
415546	MIXEUR IMMERGE ORKA 25 CV Ø HELICE INOX 600MM CABLE 20M
415547	MIXEUR IMMERGE ORKA 25 CV Ø HELICE INOX 600MM CABLE 30M
415548	MIXEUR IMMERGE ORKA 25 CV Ø HELICE INOX 600MM CABLE 40M
204512	MIXEUR IMMERGE ORKA 30 CV Ø HELICE INOX 650MM CABLE 10M
415549	MIXEUR IMMERGE ORKA 30 CV Ø HELICE INOX 650MM CABLE 20M
415550	MIXEUR IMMERGE ORKA 30 CV Ø HELICE INOX 650MM CABLE 30M
415551	MIXEUR IMMERGE ORKA 30 CV Ø HELICE INOX 650MM CABLE 40M

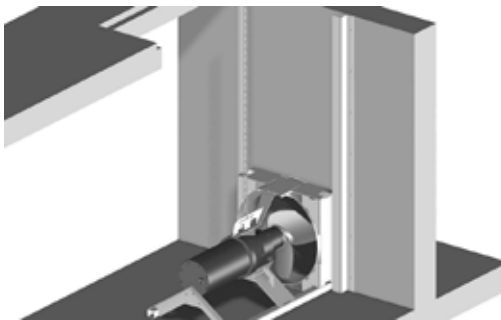

ACCESSOIRES MIXEURS SLALOM

ACCESSOIRES - MIXEUR ORKA SYSTÈME SLALOM		
N°	RÉF	DÉSIGNATION
1	204539	CADRE VIROLE POUR SYST SLALOM 700X700 HELICE 550 GALVANISEE
	204540	CADRE VIROLE POUR SYST SLALOM 700X700 HELICE 550 INOX
	204541	CADRE VIROLE POUR SYST SLALOM 700X700 HELICE 600 GALVANISEE
	204542	CADRE VIROLE POUR SYST SLALOM 700X700 HELICE 600 INOX
	204543	CADRE VIROLE POUR SYST SLALOM 700X700 HELICE 650 GALVANISEE
	204544	CADRE VIROLE POUR SYST SLALOM 700X700 HELICE 650 INOX
2	204545	PAIRE DE GLISSIERE EN Z LG 2M VERTICALE PR CADRE VIROLE-INOX
-	204547	CHAINE A MAILLONS EN INOX
3	204551	TUBE DE MAINTIEN POUR CADRE VIROLE 4M GALVANISEE
	204552	TUBE DE MAINTIEN POUR CADRE VIROLE 4M INOX
	204553	TUBE DE MAINTIEN POUR CADRE VIROLE 5M GALVANISEE
	204554	TUBE DE MAINTIEN POUR CADRE VIROLE 5M INOX
	204555	TUBE DE MAINTIEN POUR CADRE VIROLE 6M GALVANISEE
	204556	TUBE DE MAINTIEN POUR CADRE VIROLE 6M INOX
4	204557	DEMARREUR ETOILE / TRIANGLE SS DECLENCHEMENT 7,5KW
	204558	DEMARREUR ETOILE / TRIANGLE SS DECLENCHEMENT 11KW
	204559	DEMARREUR ETOILE / TRIANGLE SS DECLENCHEMENT 15KW
	204560	DEMARREUR ETOILE / TRIANGLE SS DECLENCHEMENT 18KW
	204561	DEMARREUR ETOILE / TRIANGLE SS DECLENCHEMENT 22KW
5	204565	ARMOIRE DE COMMANDE AUTO EXTERIEURE 11KW
	204566	ARMOIRE DE COMMANDE AUTO EXTERIEURE 18KW
	204567	ARMOIRE DE COMMANDE AUTO EXTERIEURE 22KW
-	412294	MARTEAU ENFONCE BURIN POUR POTENCE DE 120 ORKA
5	443266	COMMANDE AUTO A DEMARRAGE PROGRESSIF JUSQU'A 15KW POUR MIXEUR ORKA
	443267	COMMANDE AUTO A DEMARRAGE PROGRESSIF JUSQU'A 22KW POUR MIXEUR ORKA
4	446692	DEMARREUR ETOILE / TRIANGLE AV DECLENCHEUR THERMIQUE ET FUITE 11KW
	446693	DEMARREUR ETOILE / TRIANGLE AV DECLENCHEUR THERMIQUE ET FUITE 15KW
	446694	DEMARREUR ETOILE / TRIANGLE AV DECLENCHEUR THERMIQUE ET FUITE 22KW

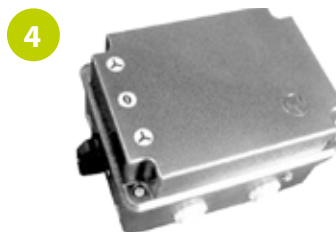
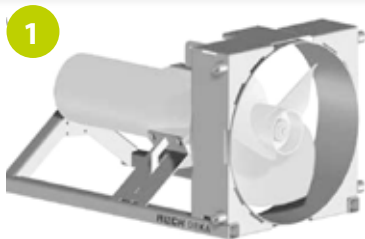

MIXEURS SLALOM

MIXEUR BLIZZARD			
RÉF	VERSION	DÉSIGNATION	
204588	VERSION GALVA CHASSIS Ø101	MIXEUR BLIZZARD 4M 10CV	HELICE Ø440
219697		MIXEUR BLIZZARD 4M 20CV	HELICE Ø500
204845		MIXEUR BLIZZARD 5M 7.5CV	HELICE Ø400
414405		MIXEUR BLIZZARD 5M 10CV	HELICE Ø440
205674		MIXEUR BLIZZARD 5M 15CV	HELICE Ø500
204957		MIXEUR BLIZZARD 5M 20CV	HELICE Ø500
219553		MIXEUR BLIZZARD 5M 25CV	HELICE Ø550
441901		MIXEUR BLIZZARD 6M 10CV	HELICE Ø440
204208		MIXEUR BLIZZARD 6M 15CV	HELICE Ø500
205366		MIXEUR BLIZZARD 6M 20CV	HELICE Ø500
219795		MIXEUR BLIZZARD 6M 25CV	HELICE Ø550
204591		MIXEUR BLIZZARD 6M 30CV	HELICE Ø600
204905		MIXEUR BLIZZARD 7M 15CV	HELICE Ø500
218843		MIXEUR BLIZZARD 7M 20CV	HELICE Ø500
205749		MIXEUR BLIZZARD 7M 25CV	HELICE Ø550
204112	VERSION INOX CHASSIS Ø101	MIXEUR BLIZZARD 4M 15CV INOX	HELICE Ø500
411173		MIXEUR BLIZZARD 4M 25CV INOX	HELICE Ø550
207776		MIXEUR BLIZZARD 4M 30CV INOX	HELICE Ø600
204893		MIXEUR BLIZZARD 5M 10CV INOX	HELICE Ø440
204863		MIXEUR BLIZZARD 5M 15CV INOX	HELICE Ø500
204671		MIXEUR BLIZZARD 5M 20CV INOX	HELICE Ø500
205806		MIXEUR BLIZZARD 5M 25CV INOX	HELICE Ø550
204632		MIXEUR BLIZZARD 6M 15CV INOX	HELICE Ø500
204582		MIXEUR BLIZZARD 6M 20CV INOX	HELICE Ø500
204833		MIXEUR BLIZZARD 6M 25CV INOX	HELICE Ø550
204700		MIXEUR BLIZZARD 6M 30CV INOX	HELICE Ø600
415295		MIXEUR BLIZZARD 7M 15CV INOX	HELICE Ø500
204823	MIXEUR BLIZZARD 7M 20CV INOX	HELICE Ø500	
219573	VERSION GALVA CHASSIS Ø140	MIXEUR BLIZZARD 4M 20CV JUMBO	HELICE Ø500
441150		MIXEUR BLIZZARD 6M 25CV JUMBO	HELICE Ø550
441629		MIXEUR BLIZZARD 7M 20CV JUMBO	HELICE Ø500
415227		MIXEUR BLIZZARD 7M 25CV JUMBO	HELICE Ø550
441310		MIXEUR BLIZZARD 8M 15CV JUMBO	HELICE Ø500
204598		MIXEUR BLIZZARD 8M 25CV JUMBO	HELICE Ø550
411713	MIXEUR BLIZZARD 9M 25CV JUMBO	HELICE Ø550	



MIXEURS SLALOM

MIXEUR JAGUAR

RÉF	DÉSIGNATION	
204800	MIXEUR JAGUAR TURBO 4M	NU
204801	MIXEUR JAGUAR TURBO 5M	NU
400062	MIXEUR JAGUAR TURBO 6M	NU
400075	MIXEUR JAGUAR JUMBO 4M	NU
400088	MIXEUR JAGUAR JUMBO 5M	NU
400101	MIXEUR JAGUAR JUMBO 6M	NU
400114	MIXEUR JAGUAR JUMBO 7M	NU
400127	MIXEUR JAGUAR JUMBO45 4M	NU
400136	MIXEUR JAGUAR JUMBO45 5M	NU
400145	MIXEUR JAGUAR JUMBO45 6M	NU
400154	MIXEUR JAGUAR JUMBO45 7M	NU



ACCESSOIRES - MIXEUR JAGUAR

N°	RÉF	VERSION	DÉSIGNATION
1	218278	HELICE REFOULANTE ARBRE Ø35 JAUNE	HELICE HAUTE PERFORMANCE Ø500 ARBRE Ø35 REFOULANTE
	218276		HELICE HAUTE PERFORMANCE Ø550 ARBRE Ø35 REFOULANTE
	218277		HELICE HAUTE PERFORMANCE Ø600 ARBRE Ø35 REFOULANTE
	219968		HELICE HAUTE PERFORMANCE Ø650 ARBRE Ø35 REFOULANTE
2	218332	HELICE ASPIRANTE ARBRE Ø35 ROUGE	HELICE HAUTE PERFORMANCE Ø500 ARBRE Ø35 ASPIRANTE
	204708		HELICE HAUTE PERFORMANCE Ø550 ARBRE Ø35 ASPIRANTE
	219385		HELICE HAUTE PERFORMANCE Ø600 ARBRE Ø35 ASPIRANTE
			HELICE HAUTE PERFORMANCE Ø650 ARBRE Ø35 ASPIRANTE
3	204909	HELICE REFOULANTE ARBRE Ø45 JAUNE	HELICE HAUTE PERFORMANCE Ø550 ARBRE Ø45 REFOULANTE
	204813		HELICE HAUTE PERFORMANCE Ø600 ARBRE Ø45 REFOULANTE
	204621		HELICE HAUTE PERFORMANCE Ø650 ARBRE Ø45 REFOULANTE
	443261		HELICE HAUTE PERFORMANCE Ø700 ARBRE Ø45 REFOULANTE
2	204720	HELICE ASPIRANTE ARBRE Ø35 ROUGE	HELICE HAUTE PERFORMANCE Ø600 ARBRE Ø45 ASPIRANTE
	414332		HELICE HAUTE PERFORMANCE Ø650 ARBRE Ø45 ASPIRANTE

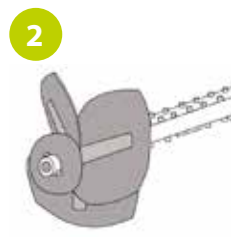
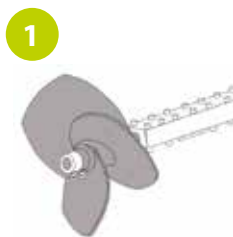

MIXEURS SLALOM

MIXEUR BRAS DE BRASSAGE			
RÉF	VERSION	DÉSIGNATION	
218892	VERSION GALVA CHASSIS Ø101	BRAS DE BRASSAGE 4M	HELICE Ø500
204970		BRAS DE BRASSAGE 4,5M	HELICE Ø500
219022		BRAS DE BRASSAGE 5M	HELICE Ø500
218891		BRAS DE BRASSAGE 6M	HELICE Ø500
204590		BRAS DE BRASSAGE 7M	HELICE Ø500
204682	VERSION INOX CHASSIS Ø101	BRAS DE BRASSAGE 4M INOX	HELICE Ø500
411322		BRAS DE BRASSAGE 5M INOX	HELICE Ø500
204723		BRAS DE BRASSAGE 6M INOX	HELICE Ø500
414404		BRAS DE BRASSAGE 7M INOX	HELICE Ø500
204960	VERSION GALVA CHASSIS Ø140 ARBRE Ø35	BRAS DE BRASSAGE 4M JUMBO	HELICE Ø500
414837		BRAS DE BRASSAGE 4,5M JUMBO	HELICE Ø500
205764		BRAS DE BRASSAGE 5M JUMBO	HELICE Ø500
219450		BRAS DE BRASSAGE 6M JUMBO	HELICE Ø500
204602		BRAS DE BRASSAGE 7M JUMBO	HELICE Ø500
204745		BRAS DE BRASSAGE 8M JUMBO	HELICE Ø500
205975	VERSION GALVA CHASSIS Ø140 ARBRE Ø45	BRAS DE BRASSAGE 5M JUMBO45	HELICE Ø600
204673		BRAS DE BRASSAGE 6M JUMBO45	HELICE Ø600
204499		BRAS DE BRASSAGE 7M JUMBO45	HELICE Ø600
415244		BRAS DE BRASSAGE 8M JUMBO45	HELICE Ø600
414707		BRAS DE BRASSAGE 9M JUMBO45	HELICE Ø600
205669	VERSION CADRE DOUBLE GALVA CHASSIS Ø101	BRAS DE BRASSAGE A CADRE DOUBLE	5M TURBO HELICE Ø500
219261		BRAS DE BRASSAGE A CADRE DOUBLE	6M TURBO HELICE Ø500
204626	VERSION CADRE DOUBLE GALVA CHASSIS Ø140	BRAS DE BRASSAGE A CADRE DOUBLE	5M JUMBO HELICE Ø500
204793		BRAS DE BRASSAGE A CADRE DOUBLE	6M JUMBO HELICE Ø500
205452		BRAS DE BRASSAGE A CADRE DOUBLE	7M JUMBO HELICE Ø600
204641	VERSION CADRE DOUBLE GALVA CHASSIS Ø140 ARBRE Ø45	BRAS DE BRASSAGE A CADRE DOUBLE	5M JUMBO45 HELICE Ø600
204494		BRAS DE BRASSAGE A CADRE DOUBLE	6M JUMBO45 HELICE Ø600
204616		BRAS DE BRASSAGE A CADRE DOUBLE	7M JUMBO45 HELICE Ø600



MIXEURS SLALOM

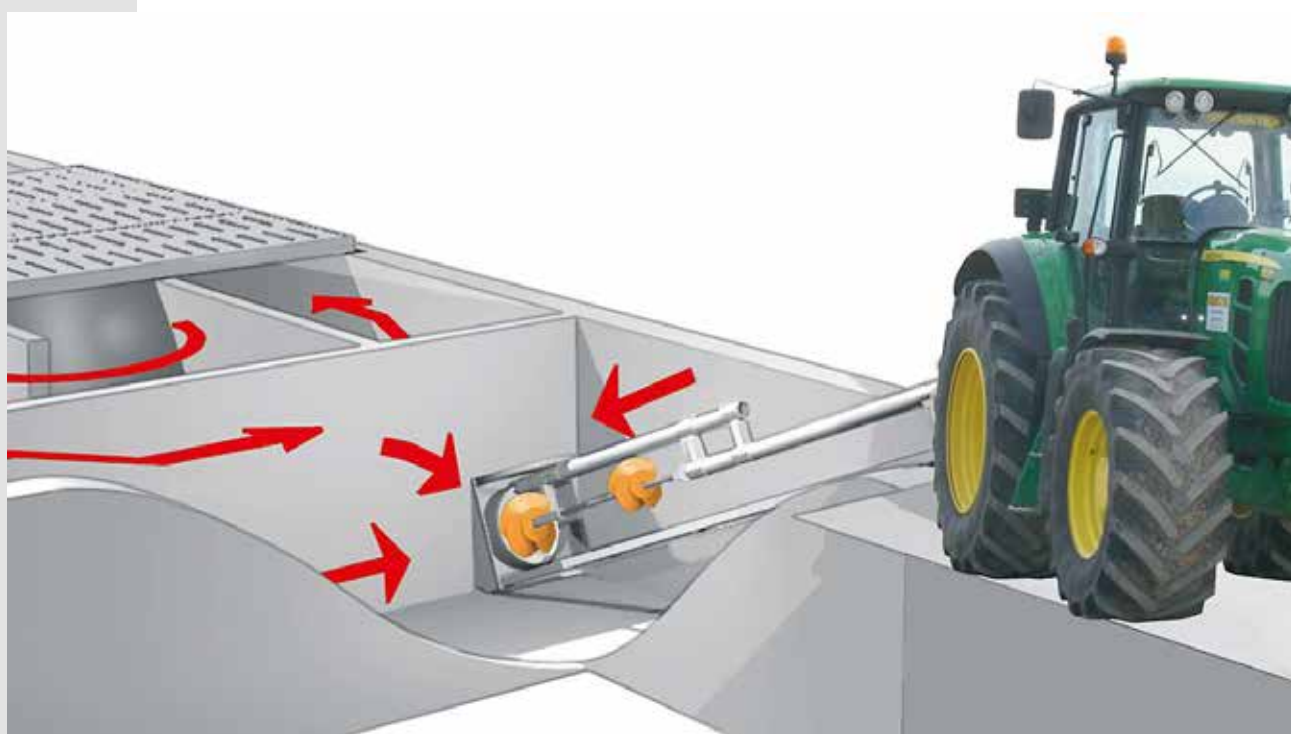

ACCESSOIRES MIXEURS SLALOM

ACCESSOIRES - MIXEURS BRAS DE BRASSAGE		
N°	RÉF	DÉSIGNATION
1	204681	BAIGNOIRE POUR MIXEUR RECK
2	218705	CAISSON A SCELLER/CHEVILLER PR OUVERTURE 80X80
	205223	CAISSON A SCELLER/CHEVILLER PR OUVERTURE 80X80 INOX
-	442833	GOUJON D'ANCRAGE FIL TOTAL INOX 12X125/30MM POUR CAISSON A SCELLER
3	218894	CAISSON A SCELLER A ANGLE DROIT
	219701	CAISSON A SCELLER A ANGLE DROIT INOX
4	218896	PAIRE DE GLISSIERE A VISSER LG 4M
	218706	PAIRE DE GLISSIERE A VISSER LG 5M
	218895	PAIRE DE GLISSIERE A VISSER LG 6M
	205453	PAIRE DE GLISSIERE A VISSER LG 7M
	413060	PAIRE DE GLISSIERE A VISSER LG 1M
	204743	RACCORD LONGITUDINAL DE GLISSIERES
	219698	PAIRE DE GLISSIERE A VISSER LG 4M INOX
5	204892	PAIRE DE GLISSIERE A VISSER LG 5M INOX
	206523	PAIRE DE GLISSIERE A VISSER LG 6M INOX
	414406	PAIRE DE GLISSIERE A VISSER LG 7M INOX
	204702	RACCORD LONGITUDINAL DE GLISSIERES INOX
	205950	CADRE VIROLE 70X70 PR CHASSIS Ø101 PR HELICE Ø440
	218704	CADRE VIROLE 70X70 PR CHASSIS Ø101 PR HELICE Ø500
	219552	CADRE VIROLE 70X70 PR CHASSIS Ø101 PR HELICE Ø550
	219432	CADRE VIROLE 70X70 PR CHASSIS Ø101 PR HELICE Ø600
	219700	CADRE VIROLE INOX 70X70 PR CHASSIS Ø101 PR HELICE Ø500
	411323	CADRE VIROLE INOX 70X70 PR CHASSIS Ø101 PR HELICE Ø600
6	205451	CADRE VIROLE 70X70 PR CHASSIS Ø140 PR HELICE Ø500
	205960	CADRE VIROLE 70X70 PR CHASSIS Ø140 PR HELICE Ø550
	219451	CADRE VIROLE 70X70 PR CHASSIS Ø140 PR HELICE Ø600
	204900	CADRE VIROLE 70X70 PR CHASSIS Ø140 PR HELICE Ø650
	411189	CADRE VIROLE 70X70 PR CHASSIS Ø140 PR HELICE Ø600 INOX
7	204685	CADRE VIROLE DETACHABLE PR CHASSIS Ø101
	204583	CADRE VIROLE DETACHABLE PR CHASSIS Ø140
7	218331	HACHEUR HAUTE PERFORMANCE PR MIXEUR RECK PR ARBRE Ø35
	204814	HACHEUR HAUTE PERFORMANCE PR MIXEUR RECK PR ARBRE Ø45

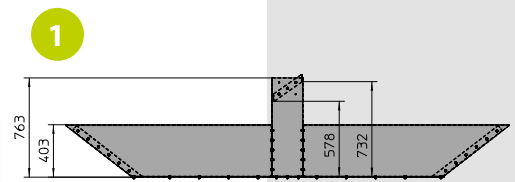

2



3



4



5



6



7



ACCESSOIRES MIXEURS SLALOM

ACCESSOIRES - MIXEUR BRAS DE BRASSAGE		
N°	RÉF	DÉSIGNATION
1	204670	HACHEUR HAUTE PERFORMANCE PR MIXEUR RECK PR ARBRE Ø35 INOX
2	218897	CHEVALET FIXE POUR CHASSIS Ø101
	219452	CHEVALET FIXE POUR CHASSIS Ø140
	219699	CHEVALET FIXE POUR CHASSIS Ø101 INOX
	411193	CHEVALET FIXE POUR CHASSIS Ø140 INOX
3	218844	CHEVALET A FIXATION REGLABLE Ø101
	205766	CHEVALET A FIXATION REGLABLE Ø140
	204830	CHEVALET A FIXATION REGLABLE Ø101 INOX
	204697	CHEVALET A FIXATION REGLABLE Ø140 INOX
4	205502	CHEVALET TELESCOPIQUE PR CHASSIS Ø101
	204777	CHEVALET TELESCOPIQUE PR CHASSIS Ø140
	204699	CHEVALET TELESCOPIQUE PR CHASSIS Ø101 INOX
	204696	CHEVALET TELESCOPIQUE PR CHASSIS Ø140 INOX
5	442167	ANODE D'USURE POUR MIXEUR
6	205422	CROCHET DE TRANSPORT PR CHASSIS Ø101
	204744	CROCHET DE TRANSPORT PR CHASSIS Ø140
7	219554	COMBINE PRISE DE FORCE PR MIXEUR BLIZZARD
8	204603	COMMANDE AUTOMATIQUE A DEMARRAGE PROGRESSIF POUR 15KW/20CV
	204604	COMMANDE AUTOMATIQUE A DEMARRAGE PROGRESSIF POUR 18KW/25CV
	204605	COMMANDE AUTOMATIQUE A DEMARRAGE PROGRESSIF POUR 22KW/30CV
9	204884	VERSION A CADRE DOUBLE Ø101AV HELICE Ø440 SURNAGEANTE
	218645	CADRE VIROLE CARRE POUR CADRE DOUBLE PR CHASSIS Ø101
	204597	VERSION A CADRE DOUBLE Ø140 AV HELICE Ø440 SURNAGEANTE
	205454	CADRE VIROLE CARRE POUR CADRE DOUBLE PR CHASSIS Ø140
	204832	VERSION A CADRE DOUBLE Ø101AV HELICE Ø440 INOX
	204831	CADRE VIROLE CARRE POUR CADRE DOUBLE PR CHASSIS Ø101 INOX
	206524	CADRE VIROLE CARRE PR CADRE DOUBLE PR CHASSIS Ø140 INOX

1

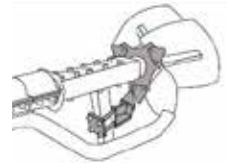

2



3

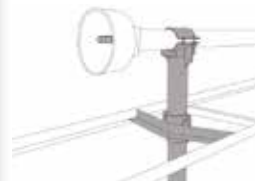

4

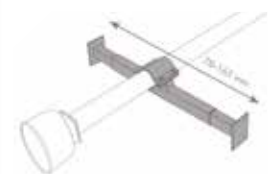

5



9

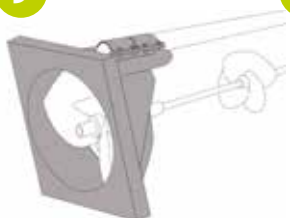

8



7



6



MIXEURS SUR POTENCE

MIXEUR ORKA	
RÉF	DÉSIGNATION
204508	MIXEUR IMMERGE ORKA 10 CV Ø HELICE INOX 480MM CABLE 10M
415531	MIXEUR IMMERGE ORKA 10 CV Ø HELICE INOX 480MM CABLE 20M
415532	MIXEUR IMMERGE ORKA 10 CV Ø HELICE INOX 480MM CABLE 30M
415533	MIXEUR IMMERGE ORKA 10 CV Ø HELICE INOX 480MM CABLE 40M
204509	MIXEUR IMMERGE ORKA 15 CV Ø HELICE INOX 500MM CABLE 10M
415534	MIXEUR IMMERGE ORKA 15 CV Ø HELICE INOX 500MM CABLE 20M
415535	MIXEUR IMMERGE ORKA 15 CV Ø HELICE INOX 500MM CABLE 30M
415536	MIXEUR IMMERGE ORKA 15 CV Ø HELICE INOX 500MM CABLE 40M
204510	MIXEUR IMMERGE ORKA 20 CV Ø HELICE INOX 550MM CABLE 10M
415543	MIXEUR IMMERGE ORKA 20 CV Ø HELICE INOX 550MM CABLE 20M
415544	MIXEUR IMMERGE ORKA 20 CV Ø HELICE INOX 550MM CABLE 30M
415545	MIXEUR IMMERGE ORKA 20 CV Ø HELICE INOX 550MM CABLE 40M
204511	MIXEUR IMMERGE ORKA 25 CV Ø HELICE INOX 600MM CABLE 10M
415546	MIXEUR IMMERGE ORKA 25 CV Ø HELICE INOX 600MM CABLE 20M
415547	MIXEUR IMMERGE ORKA 25 CV Ø HELICE INOX 600MM CABLE 30M
415548	MIXEUR IMMERGE ORKA 25 CV Ø HELICE INOX 600MM CABLE 40M
204512	MIXEUR IMMERGE ORKA 30 CV Ø HELICE INOX 650MM CABLE 10M
415549	MIXEUR IMMERGE ORKA 30 CV Ø HELICE INOX 650MM CABLE 20M
415550	MIXEUR IMMERGE ORKA 30 CV Ø HELICE INOX 650MM CABLE 30M
415551	MIXEUR IMMERGE ORKA 30 CV Ø HELICE INOX 650MM CABLE 40M

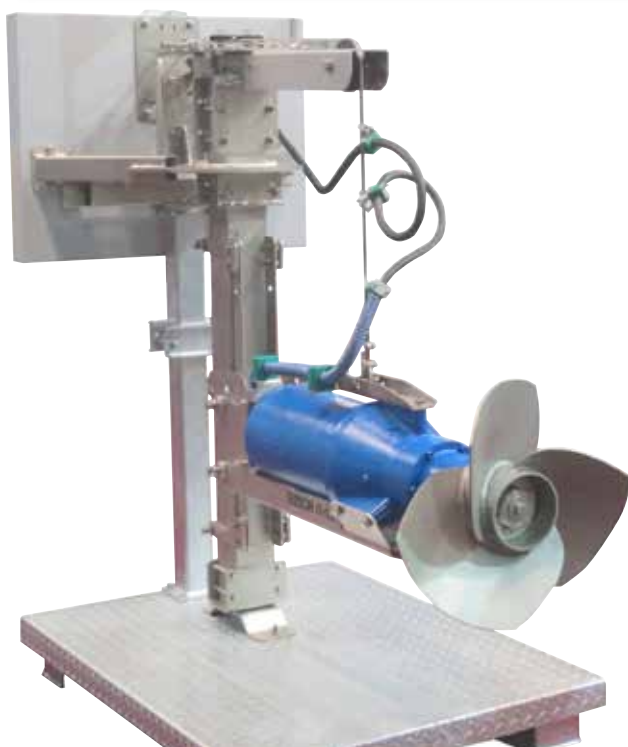
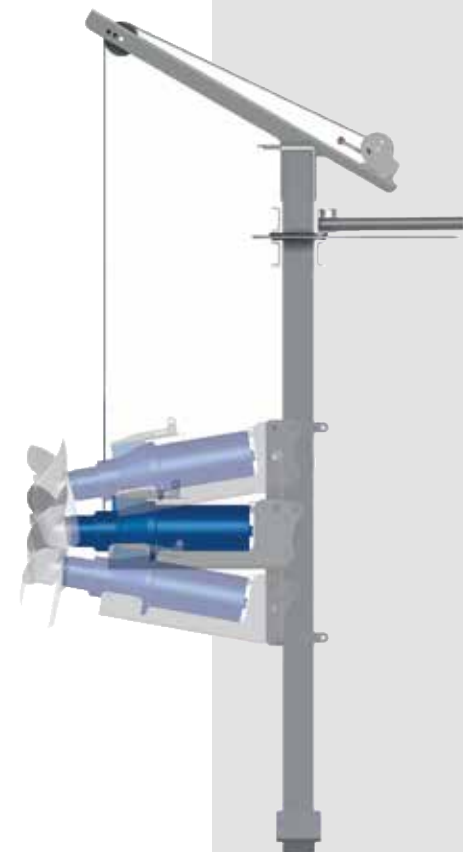

MIXEURS SUR POTENCE

ACCESSOIRES - MIXEUR ORKA SUR POTENCE

N°	RÉF	DÉSIGNATION
1a	204513	GRUE TOURNANTE AVEC TREUIL A CABLE GALVANISEE
	204514	GRUE TOURNANTE AVEC TREUIL A CABLE INOX
2	204515	TREUIL A CABLE AUTOBLOQUANT GALVANISE
	204516	TREUIL A CABLE AUTOBLOQUANT INOX
3	204517	FIXATION MURALE 120X120 GALVANISEE
	204518	FIXATION MURALE 120X120 INOX
	204519	FIXATION MURALE 150X150 INOX
4	204520	SUPPORT MOTEUR POUR TUBE 100X100 GALVANISEE
	204521	SUPPORT MOTEUR POUR TUBE 100X100 INOX
	204522	SUPPORT MOTEUR POUR TUBE 120X120 GALVANISEE
	204523	SUPPORT MOTEUR POUR TUBE 120X120 INOX
	204524	SUPPORT MOTEUR POUR TUBE 150X150 GALVANISEE
5	204525	SUPPORT MOTEUR POUR TUBE 150X150 INOX
	204526	TUBE DE POTENCE 120X120 GALVANISEE
	204527	TUBE DE POTENCE 120X120 INOX
6	204529	TUBE DE POTENCE 150X150 INOX
	204530	PALIER AU SOL POUR POTENCE 120X120 INOX
-	204531	PALIER AU SOL POUR POTENCE 150X150 INOX
	204532	BURIN POINTU POUR POTENCE INOX
8	204533	FIXATION A LA DALLE GALVANISEE
-	204534	MECANIQUE PIVOTANTE POUR RESERVOIR INOX
7	204535	SERRE-CABLE EN INOX JUSQU'A 20CV
	204536	SERRE-CABLE EN INOX JUSQU'A 30CV
-	204537	FIXATION MURALE POUR FOSSE COUVERTE POTENCE INOX 120
	204538	FIXATION MURALE POUR FOSSE COUVERTE POTENCE INOX 150
9	204557	DEMARREUR ETOILE / TRIANGLE SS DECLENCHEMENT 7,5KW
	204558	DEMARREUR ETOILE / TRIANGLE SS DECLENCHEMENT 11KW
	204559	DEMARREUR ETOILE / TRIANGLE SS DECLENCHEMENT 15KW
	204560	DEMARREUR ETOILE / TRIANGLE SS DECLENCHEMENT 18KW
10	204561	DEMARREUR ETOILE / TRIANGLE SS DECLENCHEMENT 22KW
	204565	ARMOIRE DE COMMANDE AUTO EXTERIEURE 11KW
	204566	ARMOIRE DE COMMANDE AUTO EXTERIEURE 18KW
-	204567	ARMOIRE DE COMMANDE AUTO EXTERIEURE 22KW
-	412294	MARTEAU ENFONCE BURIN POUR POTENCE DE 120 ORKA
-	443266	COMMANDE AUTO A DEMARRAGE PROGRESSIF JUSQU'A 15KW POUR MIXEUR ORKA
-	443267	COMMANDE AUTO A DEMARRAGE PROGRESSIF JUSQU'A 22KW POUR MIXEUR ORKA
9	446692	DEMARREUR ETOILE / TRIANGLE AV DECLENCHEUR THERMIQUE ET FUIE 11KW
	446693	DEMARREUR ETOILE / TRIANGLE AV DECLENCHEUR THERMIQUE ET FUIE 15KW
	446694	DEMARREUR ETOILE / TRIANGLE AV DECLENCHEUR THERMIQUE ET FUIE 22KW



9



10



MIXEURS POUR FOSSES SUR CAILLEBOTIS

MIXEUR TORRO	
RÉF	DÉSIGNATION
204612	MIXEUR TORRO HELICE Ø290 MOTEUR 7,5CV FLEC 70 AV BASCUL RECK
204947	MIXEUR TORRO HELICE Ø320 MOTEUR 10CV FLEC 70 AV BASCUL RECK
204589	MIXEUR TORRO HELICE Ø380 MOTEUR 15CV FLEC 70 AV BASCUL RECK
219921	MIXEUR TORRO HELICE Ø290 MOTEUR 7,5CV FLEC 100 AV BASCUL RECK
218281	MIXEUR TORRO HELICE Ø320 MOTEUR 10CV FLEC 100 AV BASCUL RECK
218282	MIXEUR TORRO HELICE Ø380 MOTEUR 15CV FLEC 100 AV BASCUL RECK
207052	MIXEUR TORRO HELICE Ø290 MOTEUR 7,5CV FLEC 130 AV BASCUL RECK
218283	MIXEUR TORRO HELICE Ø320 MOTEUR 10CV FLEC 130 AV BASCUL RECK
218284	MIXEUR TORRO HELICE Ø380 MOTEUR 15CV FLEC 130 AV BASCUL RECK
219565	MIXEUR TORRO HELICE Ø380 MOTEUR 15CV FLEC 160 AV BASCUL RECK

ACCESSOIRES - MIXEUR TORRO		
N°	RÉF	DÉSIGNATION
1	219420	FLECHE RABATTABLE POUR MIXEUR TORRO (à partir de 130 cm)
-	219421	ARRIVEE D'EAU AVEC VANNE DE BRANCHEMENT PR MIXEUR TORRO

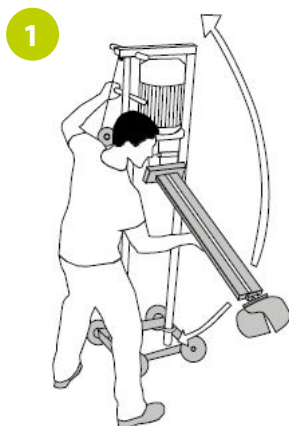
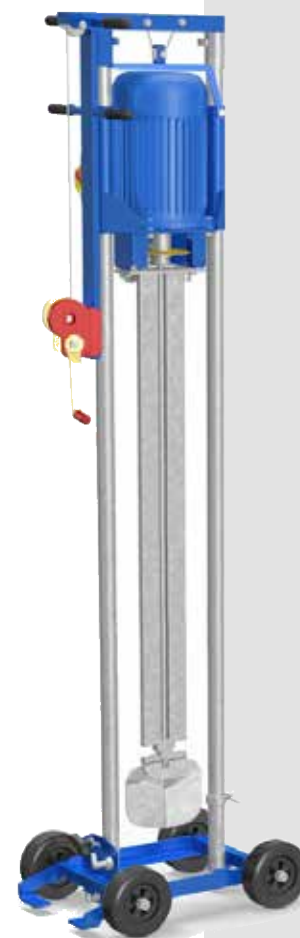

MIXEURS POUR FOSSES SUR CAILLEBOTIS

MIXEUR PORCO

RÉF	DÉSIGNATION
204210	MIXEUR PORCO-S HELICE Ø245 5,5CV HT 70 AV BASCULEMENT RECK
219703	MIXEUR PORCO-S HELICE Ø280 7,5CV HT 70 AV BASCULEMENT RECK
204732	MIXEUR PORCO-S HELICE Ø310 10CV HT 70 AV BASCULEMENT RECK
218721	MIXEUR PORCO HELICE Ø280 7,5CV HT 100 AV BASCULEMENT RECK
219151	MIXEUR PORCO-S HELICE Ø310 10CV HT 100 AV BASCULEMENT RECK
218793	MIXEUR PORCO-S HELICE Ø280 7,5CV HT 130 AV BASCULEMENT RECK
219075	MIXEUR PORCO-S HELICE Ø310 10CV HT 130 AV BASCULEMENT RECK
204818	MIXEUR PORCO-S HELICE Ø310 10CV HT 160 AV BASCULEMENT RECK

ACCESSOIRES - MIXEUR PORCO

N°	RÉF	DÉSIGNATION
1	205166	FLECHE RABATTABLE AVEC CHARNIERES POUR MIXEUR PORCO (à partir de 130 cm)
-	219448	ARRIVEE D'EAU AVEC VANNE DE BRANCHEMENT PR MIXEUR PORCO

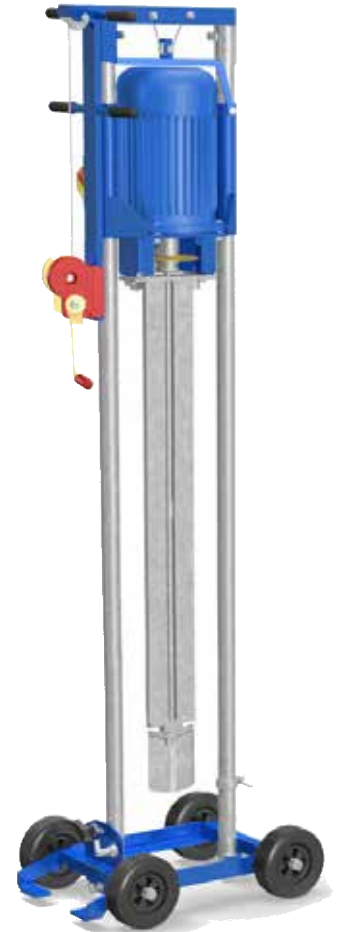

MIXEURS POUR FOSSES D'AIRES D'ATTENTE

MIXEUR FUX		
RÉF	DÉSIGNATION	
205784	LG 3M	3CV - HELICE Ø350
204840		5,5CV - HELICE Ø380
205972		7,5CV - HELICE Ø400
204850		10CV - HELICE Ø440
415245		15CV - HELICE Ø500
412538	LG 4M	5,5CV - HELICE Ø380
205785		7,5CV - HELICE Ø400
204860		10CV - HELICE Ø440
205233		15CV - HELICE Ø500



ACCESSOIRES - MIXEUR FUX		
N°	RÉF	DÉSIGNATION
1	204859	FIXATION POUR LE REGLAGE DE L'INCLINAISON PR FUX*
2	204856	POIGNEES PR MIXEUR FUX
3	204858	PIED DE PROTECTION PR MIXEUR FUX
4	204857	SYSTEME DE TRANSPORT PR MIXEUR FUX
5	204660	CROCHET DE TRANSPORT POUR FUX
6	204630	SYSTEME SOLOMOBIL POUR FUX

*EN ASSOCIATION OBLIGATOIRE AVEC LE SYSTÈME DE TRANSPORT

1



2



3



4



5



6





AGRIEST - Z.A. de la Maze - (FR) - 70360 SCEY SUR SAÔNE



+ 33 (0)3 84 92 76 76



+ 33 (0)3 84 92 72 03



contact@agriestelevage.fr